

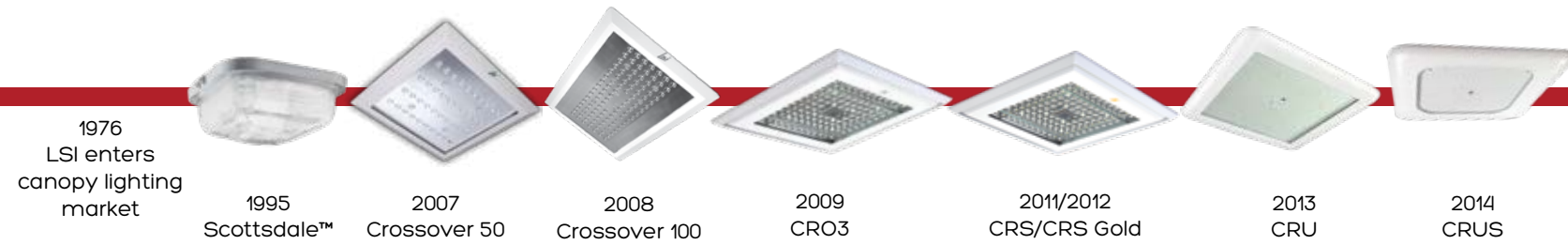

SCOTTSDALE[®] VERTEX[™]



Pioneering Petroleum Canopy Lighting Since 1976



When LSI started illuminating canopies in 1976, gas stations everywhere needed quality lighting. LSI fixtures answered the call and became a beacon for travelers nationwide.

Today, more than one million LSI canopy fixtures illuminate gas stations across the country, making LSI the undisputed market leading KING OF THE CANOPY.

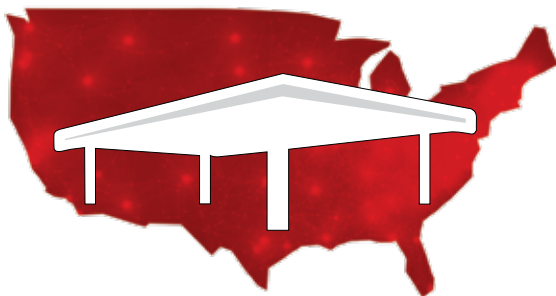

2018



SCOTTSDALE®
VERTEX™

The Best-Performing Canopy Luminaire Available



- Distributions: Symmetric & Combination Forward Throw
- Shatterproof, non-yellowing, lightweight Silicone Optics
- 5 Lumen packages: (10K, 13K, 15K, 20K, 23K)
- Simple Installation
- Low Profile, Advanced Design
- Advanced Controls
- Ease of Ordering Retrofit Accessories
- Wide Range of Retrofit Solutions

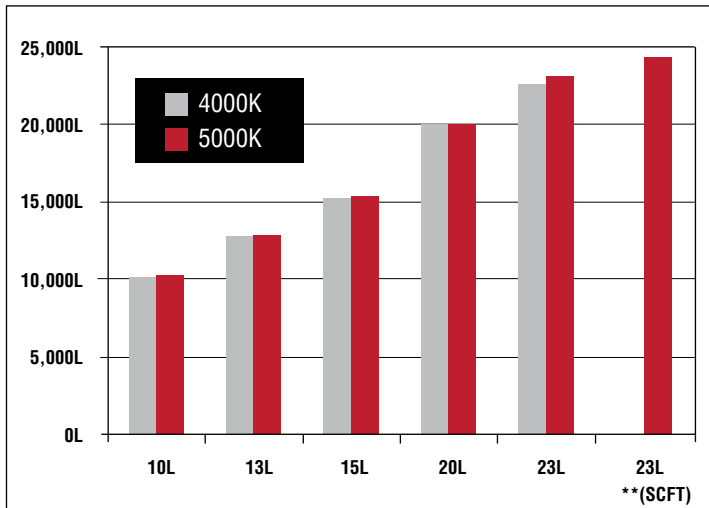

Lumens	4000K		5000K		Wattage
	Delivered Lumens	Efficacy (LPW)	Delivered Lumens	Efficacy (LPW)	
10L	10,218	156	10,306	156	66
13L	12,793	153	12,933	153	84
15L	15,209	150	15,411	150	103
20L	20,083	153	20,141	155	130
23L (SC)	22,652	149	23,150	152	153
23L (SCFT)	N/A	N/A	24,361	127	192

*LED Chips are frequently updated, therefore, values are nominal.
 ** (SCFT) Symmetric Combination Forward Throw only available in 23L @ 5000K



Silicone Optics and Combination Distributions



Design Adaptability for New Technology and Controls

Next Generation Canopy Technology

Silicone Optics

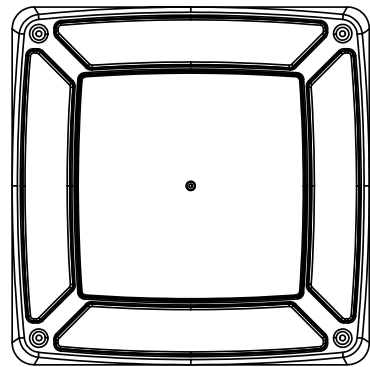

Driver Accessible Center Panel
Accessible from below the canopy, the center panel of the Vertex allows for growth as new technologies progress. There is plenty of room inside the center cavity for wireless control modules. The center panel accommodates motion and light sensors and other hardware.

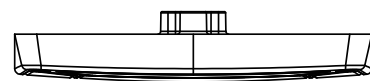

Elegant Architectural Design
Low profile, subtle and sophisticated styling compliments any environment yet durable enough to handle the harsh atmosphere of petroleum locations.

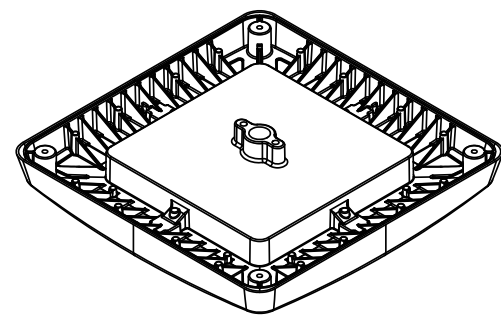

A Fixture That Breathes
Designed to allow air to pass through the fixture not only helps it perform better, but also regulates the fixture as it heats and cools. Other fixtures may have seals and gaskets that can crack due to repetitive contraction and expansion as the fixture heats up and cools down.



(SC)
Symmetric Canopy
Distribution

(SCFT)
Symmetric Combination
Forward Throw

Shatterproof
Non-Yellowing
Self-Sealing Gasket
Much Lighter than Glass
Better Light Transmission

Directional icons molded into silicone (as outlined by the red arrow at right) make for fool-proof installation of SCFT Symmetric Combination Forward Throw.



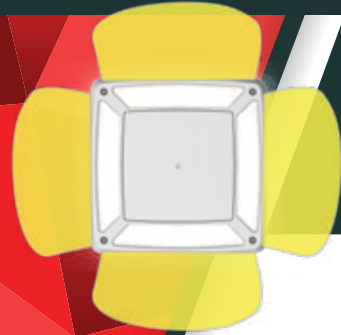

Standard Symmetric Light Distribution (SC)

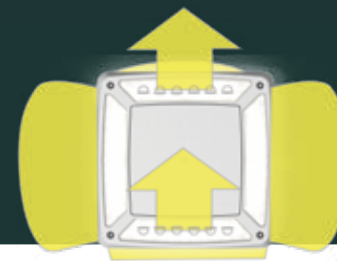

Symmetric Combination Forward Throw Light Distribution (SCFT)

(18) Symmetrical Fixtures

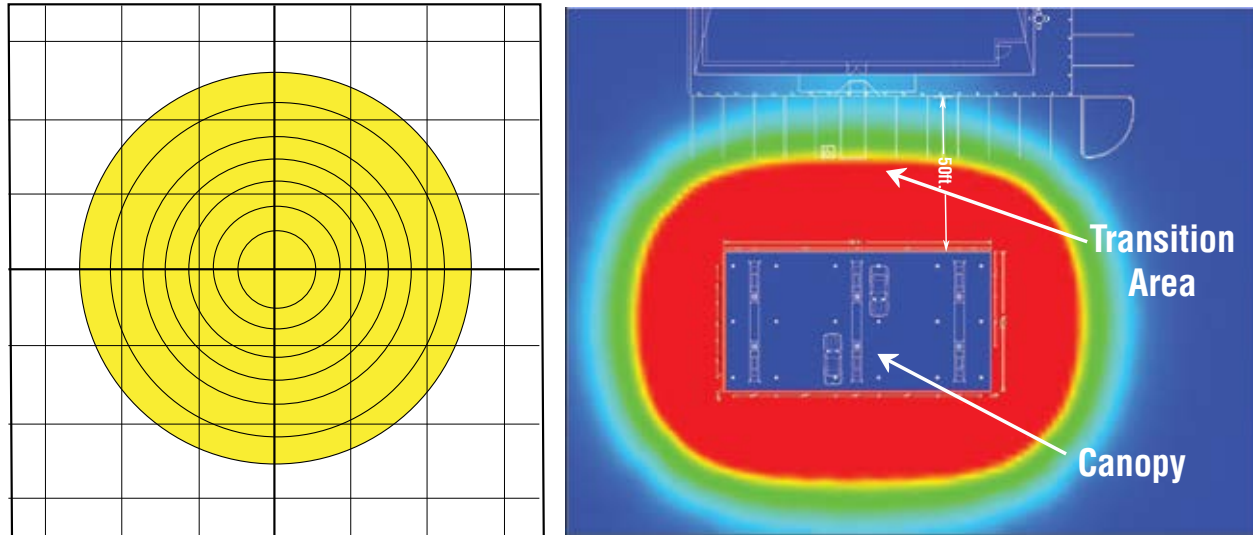

(12) Symmetrical AND (6) Combo FT Fixtures

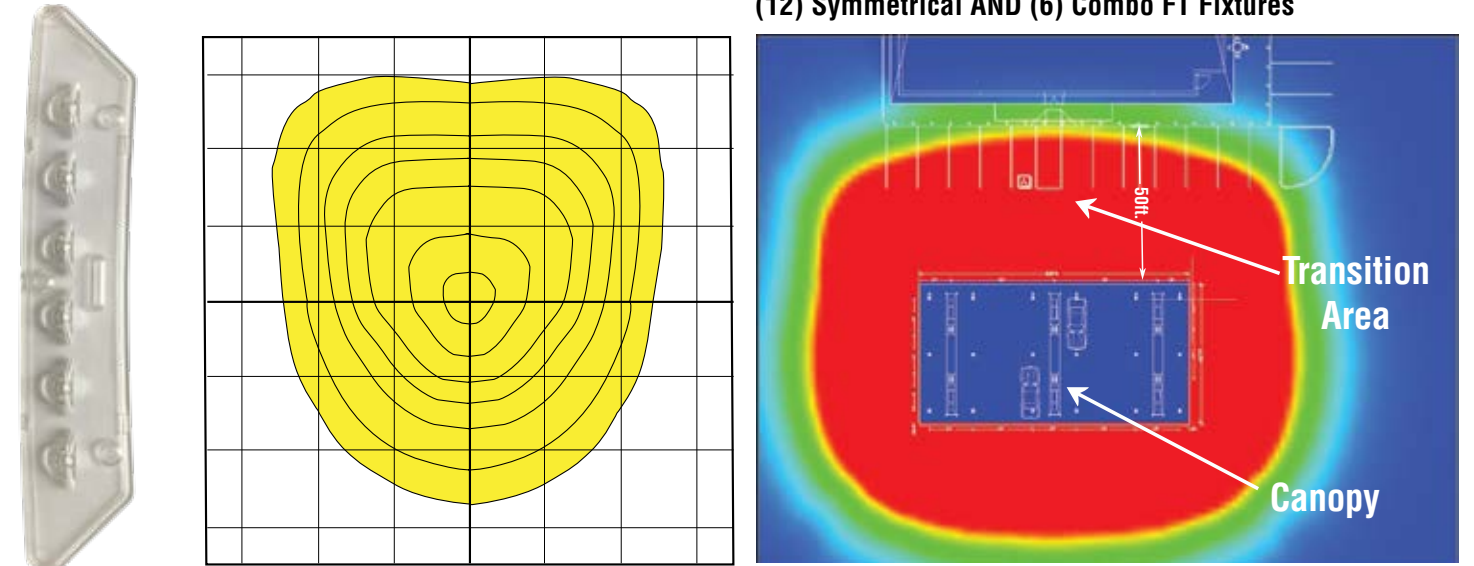

CANOPY COMPARISON									
Canopy Layout	Fixture	QTY	Fixture Lumens	Fixture Watts	Lumens/Watts	Canopy/Watts	Canopy Watts/Sq. Ft.	*Canopy/Avg.	*Transition Area Avg.
1	SCV-LED-13L-SC-50	18	12,933.0	84.3	153.0	1,717	0.39	35.41	3.43
2	SCV-LED-10L-SC-50	12	10,306.0	66.1	156.0	1,942	0.50	34.34	9.58
3	SCV-LED-13L-SC-50	12	12,933.0	84.3	153.0	2,161	0.56	39.43	9.70
4	SCV-LED-15L-SC-50	12	15,410.0	103.0	150.0	2,385	0.62	44.23	9.80
5	SCV-LED-20L-SC-50	12	20,141.0	130.3	155.0	2,713	0.70	53.38	10.03
6	SCV-LED-23L-SC-50	12	23,150.0	152.5	152.0	2,979	0.77	59.22	10.16

*Initial foot-candle values at grade.

The purpose of the Symmetric Combination Forward Throw (FT) optics is to eliminate the need for supplemental flood lighting, typically between the canopy and C-store. In addition to saving money on fixtures, this saves energy, and maintenance time.

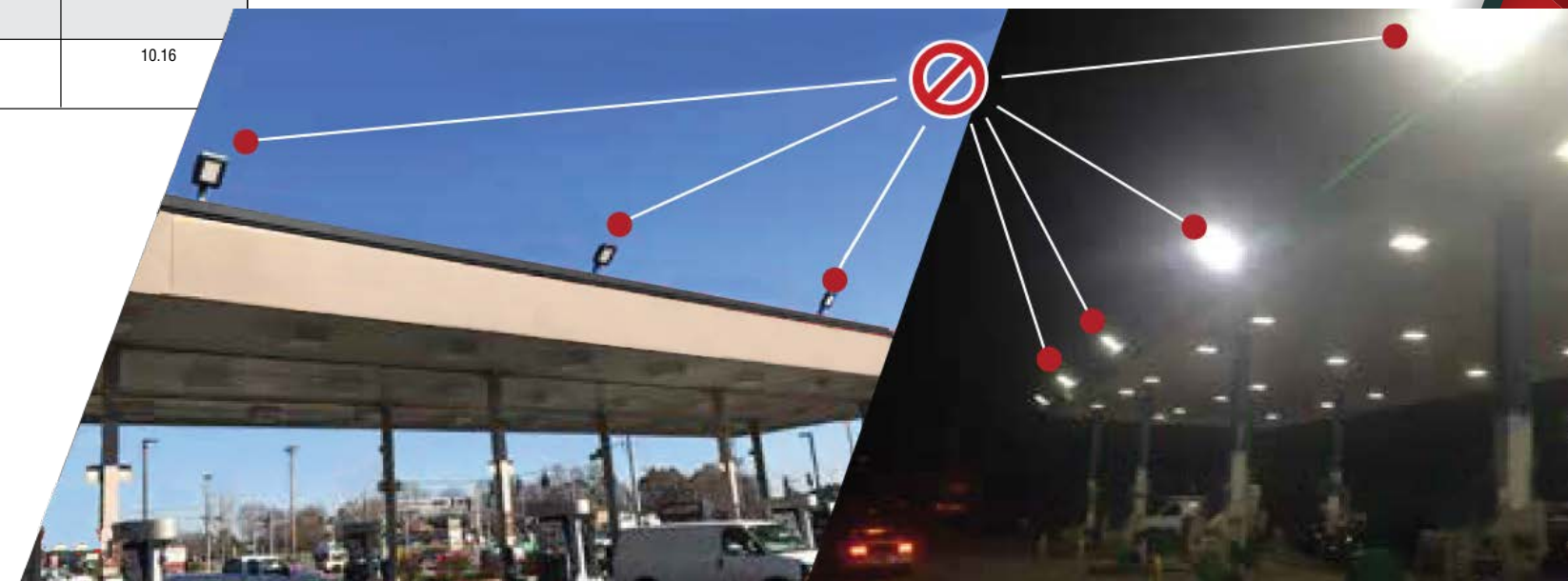

Installation & Maintenance Has Never Been Easier

Recommended Scottsdale Vertex Accessories



Simple Install



LSI continues its tradition of providing the most contractor-friendly fixtures available. Now, we have added below-canopy accessibility to make upgrades even easier.

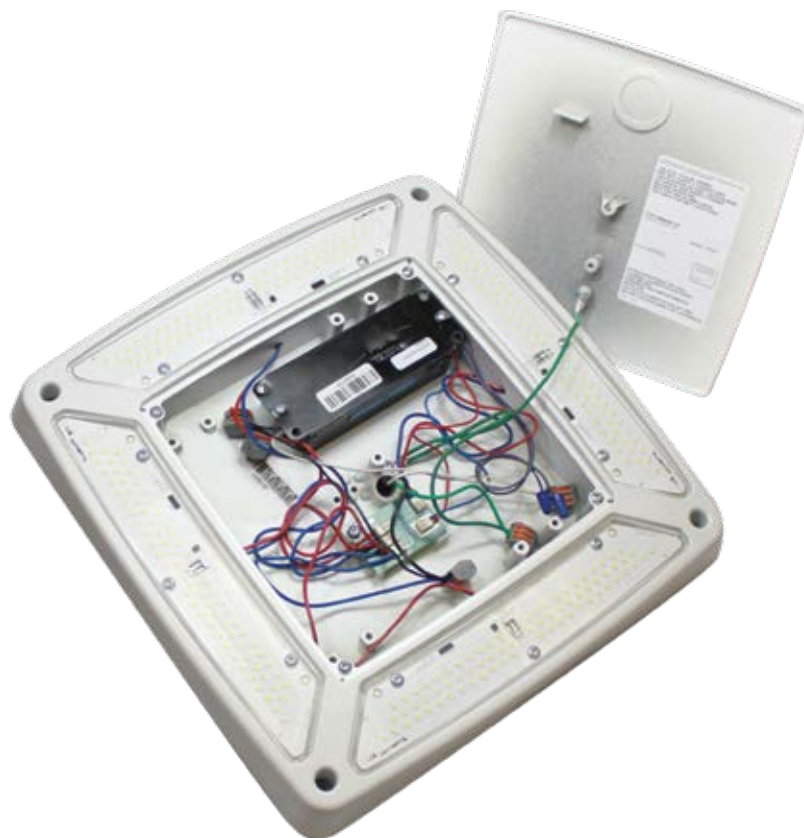

Now, all retrofit kits are shipped separately as accessories. This allows you to stock up on the Vertex fixtures you need and simply order the retrofit kits according to the specific project demands.

See specification sheet and website for more details on accessories.

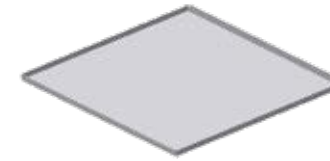

Beauty Plates

A wide selection with and without holes for 12" and 16" canopy decks.
See spec sheet for Part Numbers



Junction Box Kit

Designed to align to existing conduit of Scottsdale (HID) and many other LSI fixtures. [Includes J-Box and stem] #673429



Conduit stem

Helpful when using an existing junction box. [Includes stem and conduit nuts] #673806

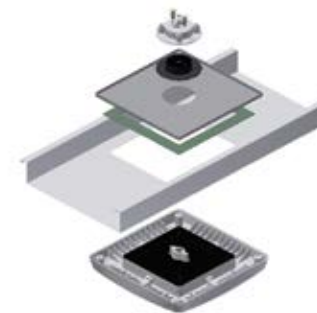

EC / ECTA / SCF to SCV

For 16" and 12" Deck Panels with larger openings [Includes all necessary plates and hardware] 16" #673425 / 12" #676001

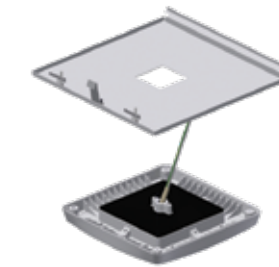

UNV Universal 2x2

[Includes all required plates and hardware] #673427

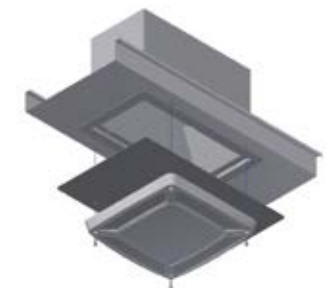

RECU Richmond

[Includes all required plates and hardware] #673426

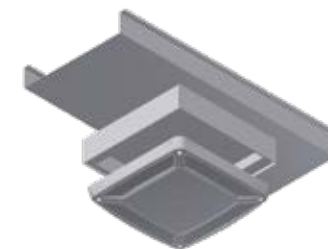

Surface Mount Box

[Includes box and required hardware] #673433

Owner Friendly / Customer Friendly



Enhanced Benefits for Owners and Customers

- Best-in-class energy efficiency
- Many output levels
- Wireless controls
- Virtually maintenance free
- Innovative retrofit options to replace out-dated fixtures
- Comfortable, safe lighting
- Hybrid distributions offer safer extended light path
- Smart styling complements facility
- Motion control available



Mounting Types

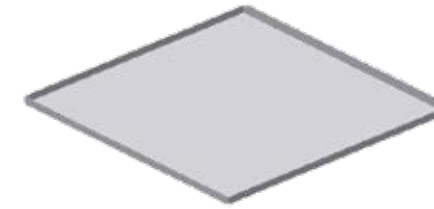

Standard Canopy Mount



Surface Mount

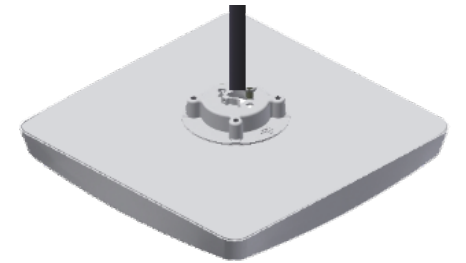

Pendant Mount
(coming soon)

Dimensions

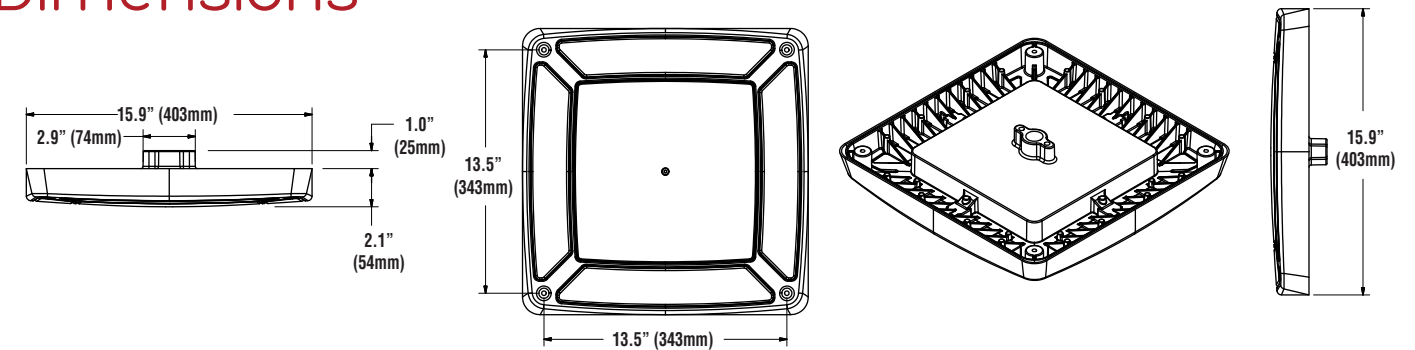

Available finishes

The Vertex is offered in three standard powder coated finishes to blend seamlessly with your environment. Check with factory for custom finishes.

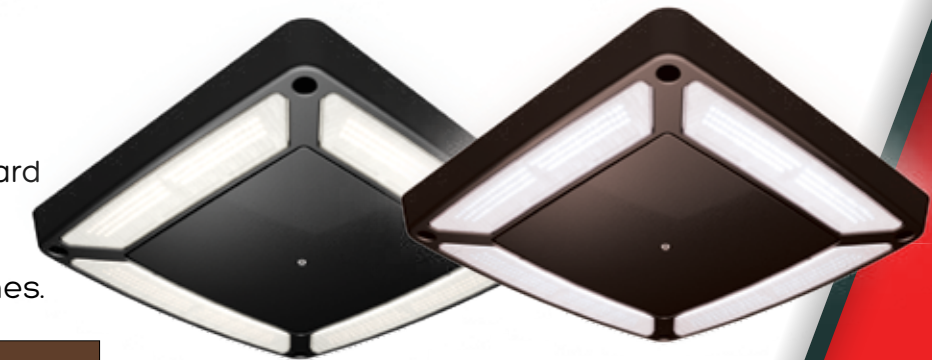

Compliance and Approvals



Proudly Manufactured in the USA

Wireless Control Options



LSI Corporate Headquarters and Assembly Facility in Blue Ash, Ohio.

Because Experience Makes the Difference

In 1976, LSI Industries forever changed the landscape of retail petroleum lighting. Smart, innovative lighting solutions by LSI became the new industry standard. Delivering an unparalleled level of petroleum market knowledge and expertise, LSI has been able to help marketers optimize their lighting to enhance and improve overall brand presence, visibility and image, all in the name of increasing traffic and sales.

Through the years, LSI has pioneered the upgrade philosophy with a number of "firsts" including:

- Reduced installation cost through the use of one-person installation designs
- Reduced maintenance through the use of ground relamping techniques
- Applied retail lighting strategies to the canopy environment with LSI's LED technology
- Improved performance through our UPK kits

- Reduced energy with the Scottsdale® 320-watt pulse-start metal halide canopy lighting fixture
- Maximum visual impact through the use of vertical lamp position in a dropped lens configuration

Today, LSI continues its legacy of innovation and excellence, pushing the LED technology envelope to greater and greater heights. As a vertically integrated manufacturer, we design and build our products around our value-driven design philosophy. Whether it's building a new site or retrofitting an existing location, LSI has the experience, products, design assistance and service capabilities to put your site in the best possible light.



Assembled in USA by a USA workforce of USA and foreign parts using state-of-the-art equipment at our award-winning manufacturing facility.

Occupancy Sensor / Daylight Sensor (IMS)

Optional integral IP66 rated passive infrared motion and daylight sensor activates switching of luminaire light levels. Standard Factory settings: High level light is activated and increased to full bright upon detection of motion. Low light level (30% maximum drive current) is activated when target zone is absent of motion activity for ~5 minutes. See coverage diagram for detection cone. Optional configurator tool allows for easy and safe programming of each luminaire from the ground level.

IMS/PC Remote Configurator Tool

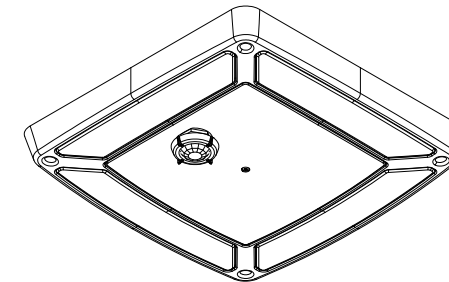

AirLink™
enabled by Synapse®

IMS Coverage Diagram

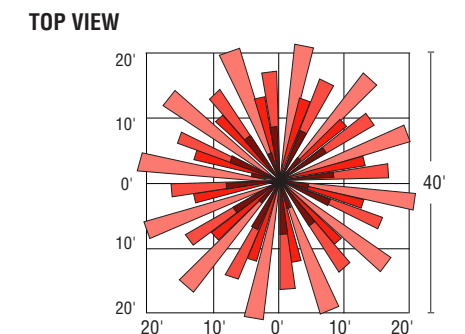
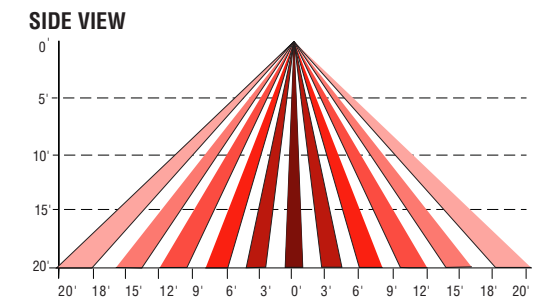

Wireless Lighting Controller (ALSC/ALSCS)

The AirLink integrated controller is a California Title 24 compliant lighting controller that provides real-time light monitoring and control with utility-grade power monitoring. It includes a 24V sensor input and power supply to connect up to two (2) sensors into the outdoor AirLink wireless lighting system.

Features

- 2% Utility Grade Power Monitoring
- Up to 80% Savings through smart dimming
- True On/Off functionality via switched relay
- Seamlessly integrates into the outdoor AirLink wireless lighting control solution & Self-healing Mesh Networking
- Relay closes on power loss
- Supports a wide range of LED drivers and fixtures
- Class 1 / Class 2 0-10V Dimming Control
- Direct Connect up to two (2) to 24V Occupancy Sensors and Photocells (consult sales for compatible list)
- Secure, over-the-air upgrades to support future enhancements
- Excellent RF Range - 1,000ft LoS between controllers
- Lights default to on for safety

Specifications

Regulatory Approvals

- FCC, IC, CE certified
- cULus Listed
- California Title 24 compliant



Power and Performance

- Operating environmental: -40°F to 131°F (-40°C to 55°C)
- Input power: 100-277 VAC +/- 10% (Max 305V) 47/64 Hz
- Switched output: Default ON; Zero Cross Switching
- Load rating: 5A @ 100V to 277V (+/- 10%)
- Dimming: 0-10V control; Output: Class 1/2 - 20mA Source Max / 50mA Sink Max
- Power monitoring: Utility grade - 2% accuracy
- Sensors inputs: 0-10V (photocell sensors), 0-24V (all other sensors); Sensor power supply: 24VDC @ 50mA

Other

- Radio: SNAP 2.4 GHz; 802.15.4; +20 dBm Transmit Power; -105 dBm Receive Sensitivity
- Warranty: 5 years

For Wireless Controls:

Sales
controls.sales@lsi-industries.com

Support
controls.support@lsi-industries.com
1 (800) 436-7800 (support, option 8)

More information
For more information on AirLink, visit our website at www.lsi-airlink.com/airlink



www.lsi-industries.com/vertex

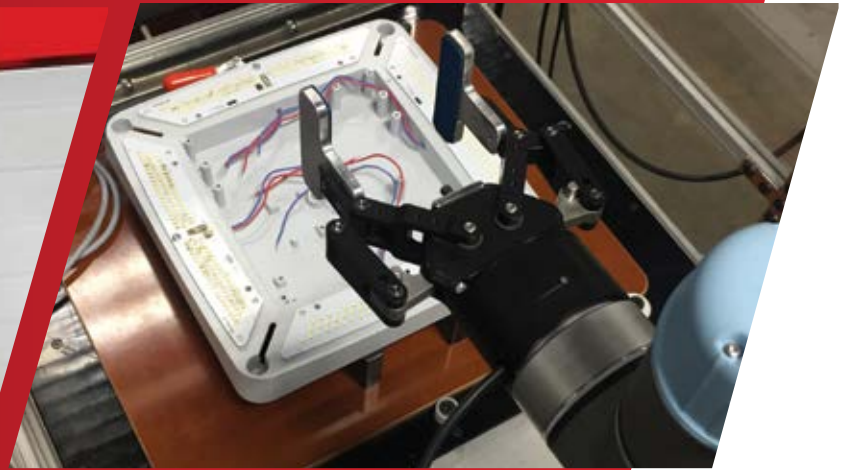

Phone 513.793.3200
Fax 866.316.7126

LSI Industries Inc
10000 Alliance Road
Cincinnati, Ohio 45242



©2018 LSI Industries Inc.
Printed in U.S.A.